



160RE

UNOKLIMA

XT160

QUICK-GUIDE

DK: QUICK-GUIDE til konfiguration og tilslutning, side 2-4

UK: QUICK-GUIDE for connections and configurations, page 5-7



BASE



REMOTE



IPX4

TILSLUTNING

INDEN FØRSTE IBRUGTAGNING ANBEFALES DET AT LÆSE DEN KOMPLETTE BRUGSANVISNING FOR AT FORHINDRE SKADER PÅ PRODUKTET.

ELEKTRISK TILSLUTNING

MODEL BASE direkte tilslutning

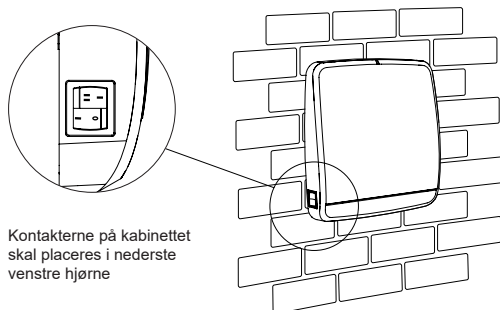
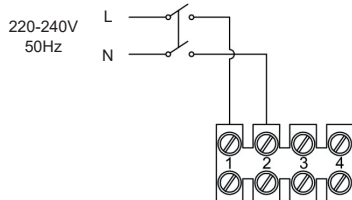

MODEL BASE tilslutning med vægkontakt (medfølger ikke)

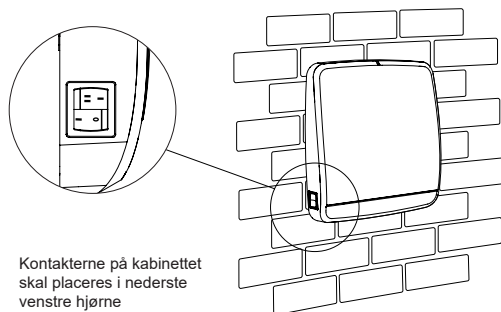
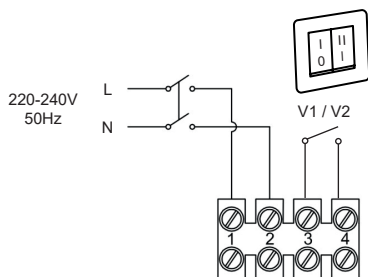

MODEL REMOTE tilslutning af en enkelt enhed

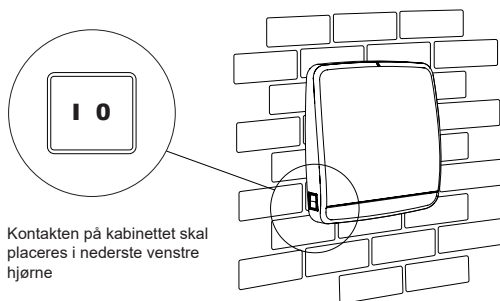
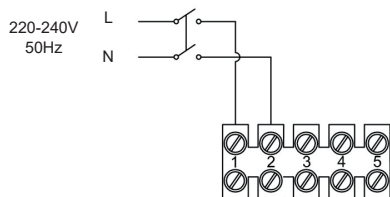

MODEL REMOTE MASTER-SLAVE tilslutning

ADVARSEL: I denne fase skal alle produkterne have hovedkontakten tændt på "0"

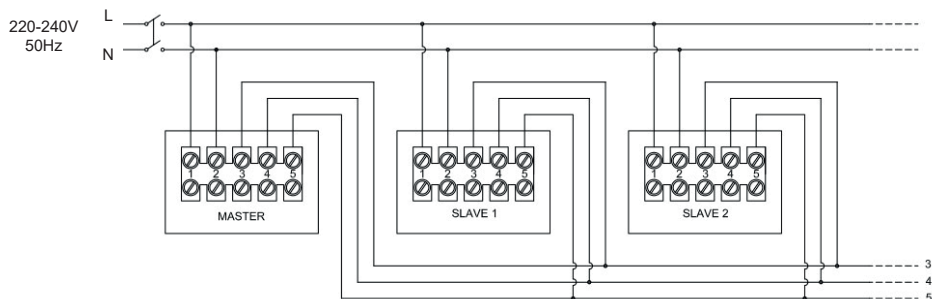

ADVARSEL:

Fugtigheds- og tussmørkesensorer registrerer værdierne fra den første tilsluttede enhed. Systemer med lange ledninger eller med en masse elektrisk/elektronisk udstyr kan forårsage signalforstyrrelser. Brug afskærmede kabler og tilslut en termineringsmodstander på 120ohm på pin 3 og 4 på terminalblokken på den sidste SLAVE-enhed.

KONFIGURATION

INDEN FØRSTE IBRUGTAGNING ANBEFALES DET AT LÆSE DEN KOMPLETTE BRUGSANVISNING FOR AT FORHINDRE SKADER PÅ PRODUKTET.

KONFIGURATION kun på MASTER-SLAVE-installation

MODEL BASE har direkte tilslutning og fungerer direkte med kontakten på enheden. Der kræves ingen konfiguration.

MODEL REMOTE

For konfiguration følges instruktionerne nedenfor under hensyntagen til at den første installerede enhed vil være MASTER og alle de andre enheder i rækkefølge SLAVE-MODSAT-MASTER og SLAVE-SAMME SOM-MASTER.

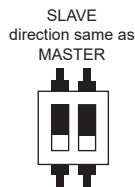
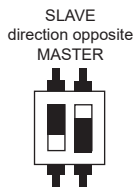
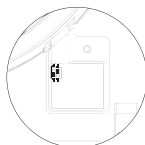
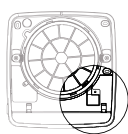

Enhed 1 MASTER	Enhed 2 SLAVE MODSAT MASTER	Enhed 3 SLAVE SAMME SOM MASTER	Enhed 4 SLAVE MODSAT MASTER	Enhed 5 OSV...
-------------------	-----------------------------------	--------------------------------------	-----------------------------------	-------------------

ADVARSEL:

MASTER er den eneste enhed, der modtager kommandoer fra fjernbetjeningen, der registrerer de omgivende forhold gennem sensorerne og dermed styrer hele systemet.

DRIFT OVERSIGT

INDEN FØRSTE IBRUGTAGNING ANBEFALES DET AT LÆSE DEN KOMPLETTE BRUGSANVISNING FOR AT FORHINDRE SKADER PÅ PRODUKTET.

MODEL BASE:

I:0 = on/off

I:II = hastighed 1 eller 2

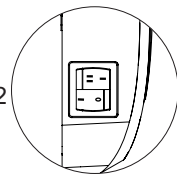

MODEL REMOTE følg fjernbetjeningsfunktionerne herunder:

FUNKTION	DRIFT	FUNKTIONS KNAPE	SKERMVISNING	FUGTIGHEDS SENSOR	TUSMØRKE SENSOR	FRONT VIPPEPANEL	STANDARD DRIFT	DRIFT I ALARM TILSTAND
AUTOMATIK				AKTIV	AKTIV	ABEN	VARME GENVINDING	UDSUGNING
OVERVÅGNING				AKTIV	AKTIV	LUKKET	STAND-BY	UDSUGNING
MANUEL				IKKE AKTIV	IKKE AKTIV	ABEN	VARME GENVINDING	IKKE AKTIV
NAT				IKKE AKTIV	IKKE AKTIV	ABEN	VARME GENVINDING	IKKE AKTIV
TIMER BOOST UDSUGNING				IKKE AKTIV	IKKE AKTIV	ABEN	UDSUGNING	IKKE AKTIV
MASTER - SLAVE LUFTRETNING				IKKE AKTIV	IKKE AKTIV	ABEN	LUFT RETNING	IKKE AKTIV
SLAVE - MASTER LUFTRETNING				IKKE AKTIV	IKKE AKTIV	ABEN	LUFT RETNING	IKKE AKTIV
UDSUGNING				IKKE AKTIV	IKKE AKTIV	ABEN	UDSUGNING	IKKE AKTIV
INDBLÆSNING				IKKE AKTIV	IKKE AKTIV	ABEN	IND BLÆSNING	IKKE AKTIV

CONNECTIONS

BEFORE THE FIRST OPERATION IT IS RECOMMENDED TO READ THE COMPLETE INSTRUCTION MANUAL TO PREVENT ANY DAMAGE TO THE PRODUCT.

ELECTRICAL CONNECTIONS

MODEL BASE direct connection

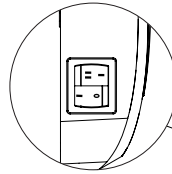
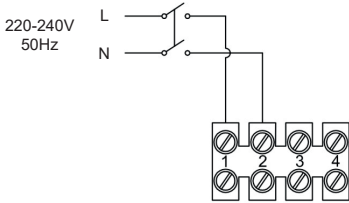

The switches on the cabinet must be positioned in the lower left corner

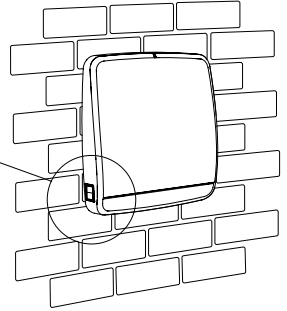

MODEL BASE connection with wall switch (not provided)

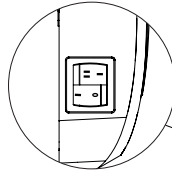
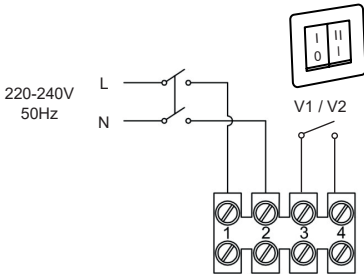

The switches on the cabinet must be positioned in the lower left corner

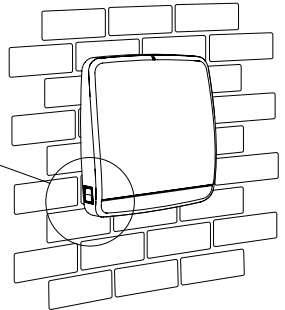

MODEL REMOTE single unit connection

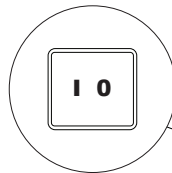
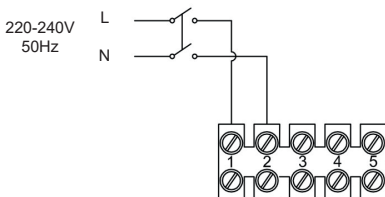

The switch on the cabinet must be positioned in the lower left corner

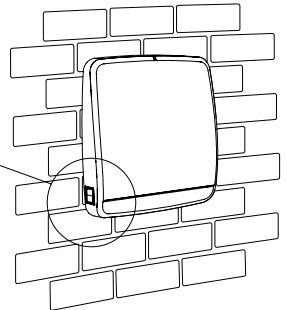

REMOTE MASTER-SLAVE connection

WARNING: During this stage all the products must have the main switch on "0"

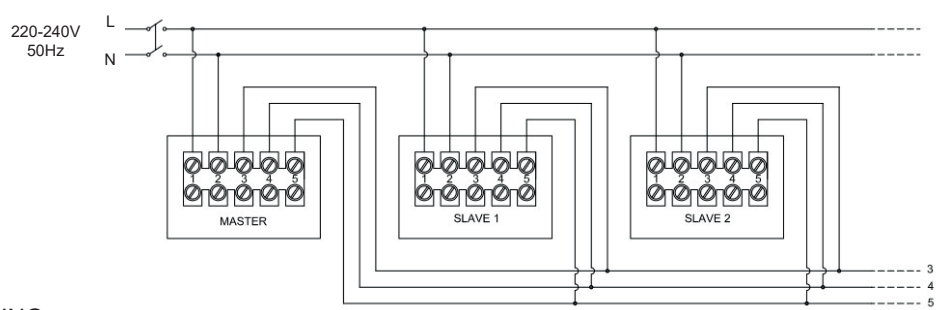

WARNING:

Humidity and twilight sensors will detect the values from the first unit connected. All systems with long wires or with a lot of electric/electronic equipment may cause signal disturbance. Use shielded cables and connect a termination resistor of 120ohm on pin 3 and 4 of the terminal block of the last SLAVE unit.

160RE - XT160 QUICK CONFIGURATIONS

BEFORE THE FIRST OPERATION IT IS RECOMMENDED TO READ THE COMPLETE INSTRUCTION MANUAL TO PREVENT ANY DAMAGE TO THE PRODUCT.

CONFIGURATION on MASTER-SLAVE installation only

MODEL BASE has a direct connection and operates directly with the switch on the left side of the unit. No configuration required.

MODEL REMOTE

For configuration, please follow the instructions below, taking into consideration that the first unit installed will be the MASTER and all the other units in sequence SLAVE-OPPOSITE TO-MASTER and SLAVE-SAME AS-MASTER.

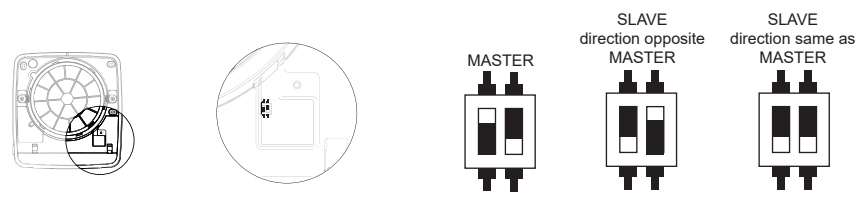

Unit 1 MASTER	Unit 2 SLAVE OPPOSITE TO MASTER	Unit 3 SLAVE SAME AS MASTER	Unit 4 SLAVE OPPOSITE TO MASTER	Unit 5 ETC...
------------------	---------------------------------------	-----------------------------------	---------------------------------------	------------------

WARNING:

The MASTER is the only unit receiving commands from remote control, that will detect the ambient conditions through the sensors and thus controlling all the system.

OPERATIONS OVERVIEW

BEFORE THE FIRST OPERATION IT IS RECOMMENDED TO READ THE COMPLETE INSTRUCTION MANUAL TO PREVENT ANY DAMAGE TO THE PRODUCT.

MODEL BASE:

l:0 = on/off

l:II = speed 1 or 2

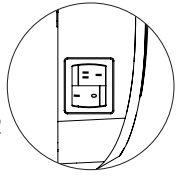

MODEL REMOTE follow the remote functions below:

Mode	Button for selection	Screen display	Humidity sensor	Twilight sensor	Shutter	Standard operation	Operation in alarm
Mode							
AUTOMATIC			Activated	Activated	Open	Heat recovery	Extraction
SURVEILLANCE			Activated	Activated	Closed	Standby	Extraction
MANUAL			Not activated	Not activated	Open	Heat recovery	Not activated
NIGHT			Not activated	Not activated	Open	Heat recovery	Not activated
TIMED BOOST EXTRACTION			Not activated	Not activated	Open	Extraction	Not activated
MASTER SLAVE AIR FLOW			Not activated	Not activated	Open	Air flow	Not activated
SLAVE MASTER AIR FLOW			Not activated	Not activated	Open	Air flow	Not activated
EXTRACTION			Not activated	Not activated	Open	Extraction	Not activated
INTAKE			Not activated	Not activated	Open	Intake	Not activated



160RE

www.ahlsell-vvs.dk
info@ahlsell-vvs.dk

0045 3819 0000

UNOKLIMA

XT160

www.vvs-trading.dk
salg@vvs-trading.dk

0045 7342 4300