

ADORA®

A01.00 DK
Brugsvejledning

Køkkenarmatur
Håndvaskarmatur



Anvendelse

- ADORA® armaturer er produceret med henblik på at forsyne en vask med koldt drikkevand, varmt vand og blandet vand til husholdning
 - ADORA® armaturer er produceret med henblik på anvendelse i baderum, køkken og bryggers i private boliger, kontorer, institutioner og lignende
-

Garanti

- Der ydes 10 års garanti mod dryp og fabriktionsfejl. Garantien dækker reservedele
 - Købskvitteringen er produktets garantibevis. Opbevar denne sammen med denne brugsvejledning
 - Det anbefales, at scanne eller kopiere kvitteringen, da tryksværte kan falme med tiden
-

Vedligeholdelse

- Armaturer med forkromede eller farvede overflader og armaturer i rustfrit stål skal aftørres umiddelbart efter brug
 - Luftblanderen skal med jævne mellemrum rengøres eller udskiftes efter behov
 - Armaturer udført i rustfrit stål skal jævnligt overfladebehandles med plejeprodukter specielt til rustfrit stål
 - Rustfrit stål, der ikke vedligeholdes, kan risikere at danne rust
 - Særligt luftblendere af rustfrit stål risikerer at danne rust, hvis de ikke vedligeholdes
-

Rengøring

- Anvend kun neutrale rengøringsmidler, der ikke er slibende eller kalkopløsende, og ikke indeholder syre, klor, eller fosfor
 - Ved brug af rengøringsmidler på spray, spray altid først midlet på en klud og påfør derefter med kluden. Ved direkte spray på armaturet er der risiko for at beskadige gummiringe og andre vitale dele
 - Anvend aldrig slibesvampe eller skuresvampe på armaturer
 - Armaturer udført i rustfrit stål skal jævnligt rengøres med rengøringsmidler fremstillet specielt til rustfrit stål
-

Montering

ADORA® armaturer skal monteres i en lovlige installation og i henhold til gældende lovgivning i det land armaturet monteres. Opstår der tvivl om korrekt installation, kontakt da en autoriseret VVS-installatør.

Installationens driftstryk skal være mellem 1 og 6 bar. Ved højere driftstryk skal der monteres trykreduktionsventiler på både koldt- og varmtvandsstilgang.

Hvis armaturet drypper eller ikke fungerer umiddelbart efter montering:

1. Luk for vandtilførslen, og lad armaturet forblive monteret
2. Se punktet 'Spørgsmål & Svar' i denne vejledning
3. Se mere på www.adora-design.com eller skriv til: info@adora-design.com

Husk at vedhæfte foto af det installerede produkt, kopi af købskvittering og også evt. installationskvittering.

Før montering:

- Pak det nye armatur ud
- Skab overblik over indholdet
- Kontroller at installationen passer til de medfølgende monteringsdele
- Hvis installationen ikke passer til de medfølgende monteringsdele, anskaf da yderligere monteringsdele hos forhandleren
- Kontroller at fastspændingsbolte kan nå igennem vasken/bordpladen
- Klargør det nødvendige værktøj
- Luk for vandtilførslen
- Afmonter det gamle armatur
- Afdæk rør og ventiler for beskyttelse mod snavs under montering

Efter montering:

- Afmonter luftblanderen
- Åbn grebet
- Åbn langsomt for vandtilførslen
- Aktiver grebet så der kommer vand ud af tuden, først koldt og derefter varmt vand
- Monter luftblanderen
- Juster evt. vandstrømmen på ventilerne, eller udskift luftblanderen til en vandsparer luftblander
- Kontroller at alle samlinger er tætte
- Gentag samme kontrol efter nogle timer for at sikre en succesfuld montering

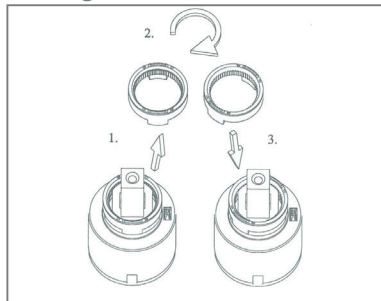
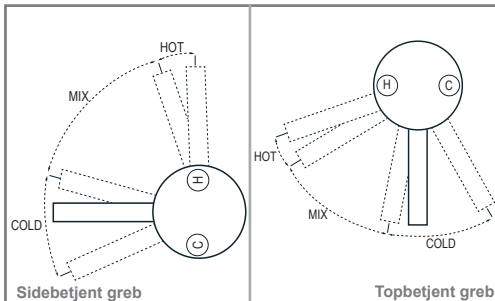
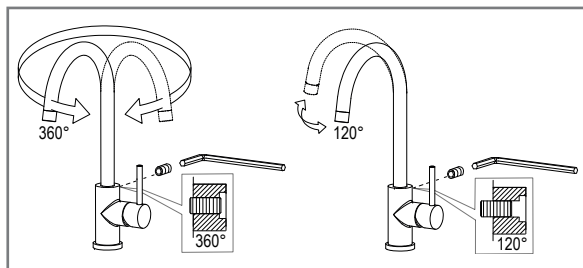
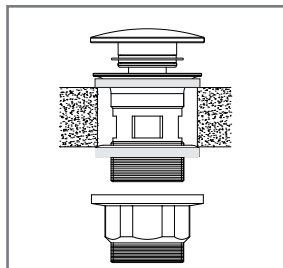
Temperaturbegrænser****Udvalgte armaturer****Koldstart funktion******Udvalgte armaturer****Indstilling af svingbegrænser på svingtud***** Kun udvalgte køkkenarmaturer****Montering af bundventil***** Kun håndvaskarmatur**

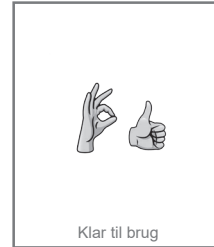
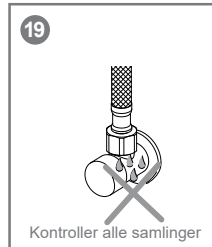
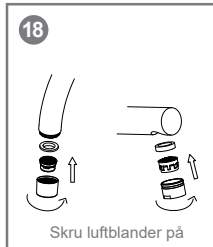
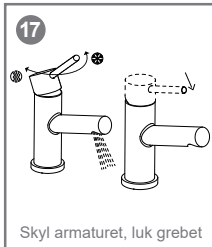
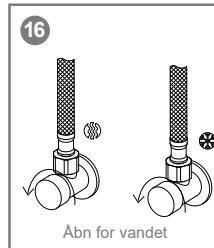
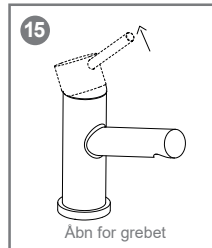
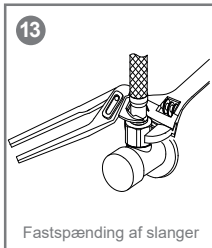
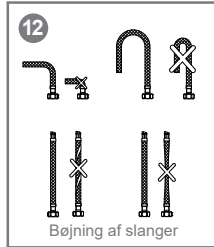
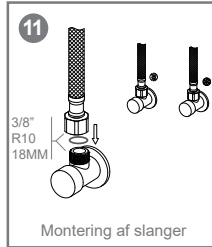
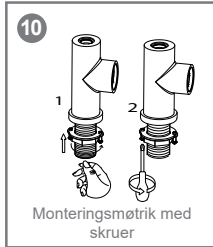
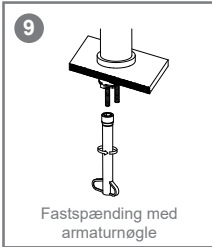
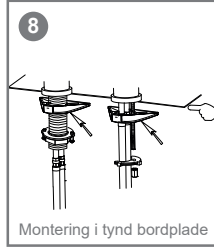
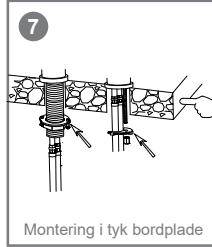
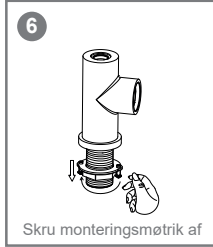
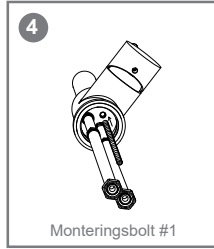
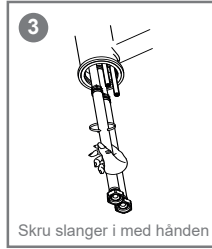
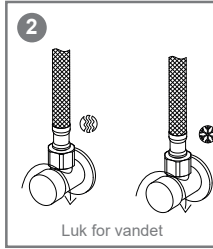
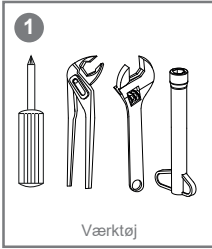

Spørgsmål & Svar

- Der kommer for lidt vand ud:
- Kontroller om der er snavs luftblander
 - Kontroller om der er snavs i tilslutningsslangerne
 - Skru mere op for vandtilførslen
 - Udskift luftblander til én med mere gennemløb
- Der kommer for meget vand ud:
- Skru ned for vandtilførslen
 - Udskift luftblander til én med mindre gennemløb
- Vandet løber konstant:
- Luk for vandtilførslen
 - Afmonter grebet
 - Udskift kartuschen
- Armaturet drypper vedvarende ud ad tuden:
- Luk for vandtilførslen
 - Afmonter grebet
 - Udskift kartuschen
- Armaturet drypper ud ad tuden i nogen tid efter lukning af grebet:
- Luftblander er tilstoppet eller tilkalket
 - Rengør, afkalk eller udskift luftblander
- Der kommer vand ud ved grebet:
- Luk for vandtilførslen
 - Afmonter grebet
 - Udskift kartuschen
- Grebet drejer trægt:
- Luk for vandtilførslen
 - Afmonter grebet
 - Udskift kartuschen
- Utætheder ved svingtud:
- Skift gummiringene ved svingtuden
 - Husk at smøre de nye gummiringe med armaturfedt
- Der løber vand ned ad slangerne:
- Armaturslangerne er skruet for lidt i, skru slangerne helt i, kun med håndkraft
 - O-ringene kan være beskadiget, udskift O-ringene
- Svingtuden drejer trægt:
- Afmonter tuden og smør gummiringene med armaturfedt
 - Armaturfedt alene kan ikke reparere en evt. utæthed. Ved utætheder skal gummiringene udskiftes. Smør de nye gummiringe med armaturfedt inden svingtuden monteres
 - Gummiringe ved svingtude er sliddele og er ikke omfattet af drypgaranti

Reservevedele

Reservevedelstegninger er tilgængelige på www.adora-design.com

Tekniske data

- Prøvetryk: 25 bar
 - Driftstryk: 1-6 bar
 - Maks. vandtemperatur: 80 °C
 - Test norm: 1-grebs armaturer EN817. 2-grebs armaturer EN 200.
-

Bortskaffelse

Gældende nationale regler om bortskaffelse og genanvendelse skal overholdes.

Ansvarsfraskrivelse

Forhandler, distributør og producent kan ikke gøres erstatningspligtig for:

- Fejl, mangler, skader og følgeskader opstået i forbindelse med fejlmontering
 - Skader på grund af kalk og frost
 - Skader på grund af snavs fra vandforsyning
 - Manglende vedligeholdelse
 - Armaturer monteret og anvendt uden at følge brugsvejledningen
 - Unødvendig voldsom behandling, der påfører armaturet skade
-

Kontakt

www.adora-design.com - info@adora-design.com

ADORA®

A01.00 UK
User manual

Kitchen faucet
Wash basin faucet



Intended use

- ADORA® faucets are manufactured to provide a kitchen sink or a wash basin with cold drinking water, hot water and mixed water for household purposes
 - ADORA® faucets are manufactured for use in; bathrooms, kitchens and utility rooms in private homes, offices, institutions a.o.
-

Guaranty

- A 10-year guaranty is granted against drip and manufacturing defects. The guaranty covers spare parts.
 - The purchase receipt is the product guaranty certificate. Keep the receipt together with the manual.
 - It is recommended to scan or copy the receipt, as printing ink may fade over time
-

Maintenance

- Faucets with chromed or colored surfaces and faucets in stainless steel must be wiped immediately after use
 - Clean the aerator frequently or replace it when needed
 - Stainless steel faucets must be treated frequently with care products made especially for stainless steel.
 - Stainless steel, which is not properly maintained, is likely to grow rust.
 - Especially stainless steel aerators may grow rust if they are not frequently maintained
-

Cleaning

- Use only neutral detergents that are not abrasive or lime-soluble and do not contain acid, chlorine, or phosphorus
 - When using sprayable detergents; always spray the detergent on a cloth first and then apply the cloth to the faucet. Direct spray on the faucet, gives a risk of damaging the rubber rings and other vital parts
 - Never use abrasive vapors or scouring sponges on faucets
 - Stainless steel faucets must be cleaned frequently with detergents made especially for stainless steel
-

Installation

ADORA® faucets shall be mounted in a legal installation and in accordance with applicable laws of the country in which the faucet is mounted. If there is any doubt about the correct installation, contact an authorized plumbing installer.

The operating pressure of the installation must be between 1 and 6 bar. At higher operating pressures, pressure reduction valves must be installed on both cold and hot water connections.

If the faucet drips or does not work immediately after installation:

1. Leave the faucet installed and shut off the water supply
2. See the 'Questions & Answers' section in this manual
3. For more information go to www.adora-design.com or write to: info@adora-design.com

Remember to attach some photos of the installed product. Furthermore, a copy of the purchase receipt and if possible, the installation receipt.

Before installation:

- Unpack the new faucet
- Make yourself an overview of the content
- Make sure that the installation is compatible with the supplied mounting parts
- If the installation does not fit together with the supplied mounting parts, obtain additional mounting parts at the dealer
- Check that fixing bolts can reach through the wash basin / tabletop
- Prepare the necessary tools
- Shut off the water supply
- Remove the old faucet
- Cover pipes and valves for protection against dirt during installation

After installation

- Remove the aerator
- Open the handle
- Slowly open the water supply
- Activate the handle; to make sure water is coming out of the spout, first cold and then hot
- Mount the aerator again
- Adjust, if necessary, water flow on the valves, or replace the aerator with a water saving aerator
- Check that all connections are tight, and not leaking
- Repeat the check again after a few hours to ensure successful assembly

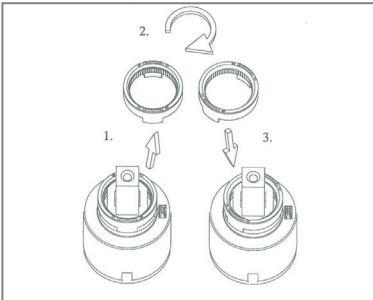
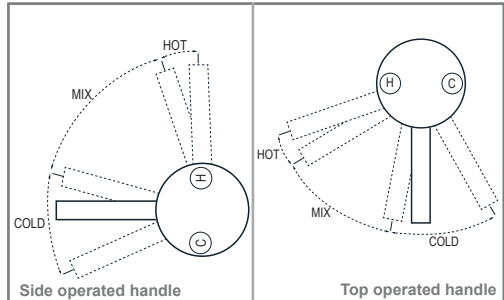
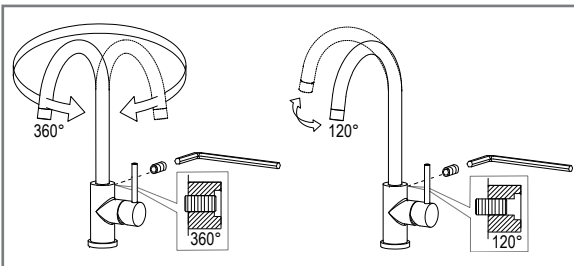
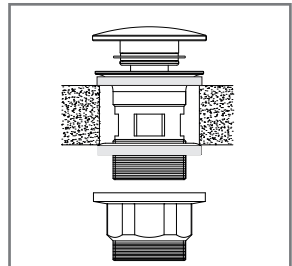
Temperature limiter****Selected faucets****Cold start function******Selected faucets****Setting of turn limiter on swivel spout****** Selected kitchen faucets****Mounting of waste valve******Wash basin faucets only**

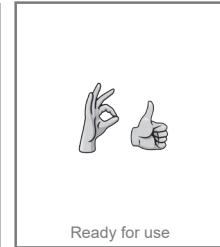
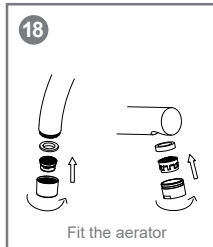
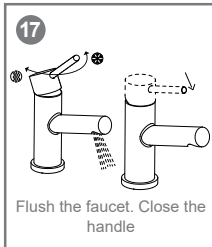
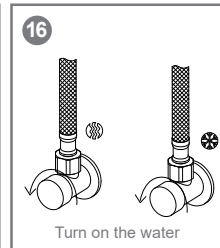
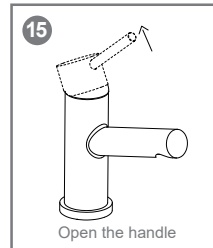
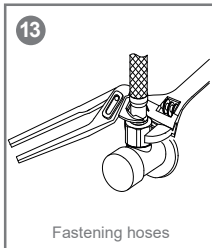
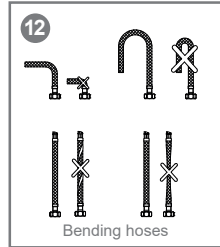
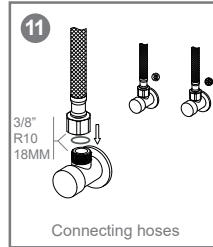
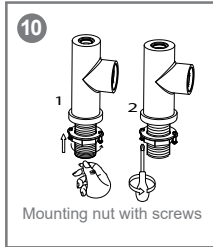
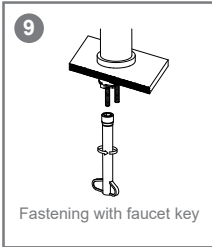
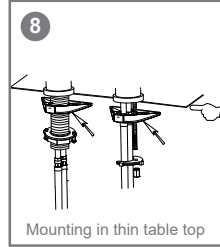
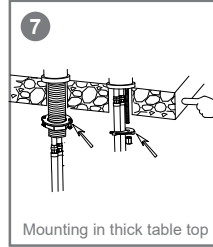
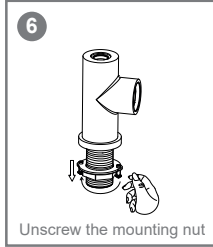
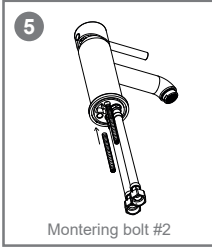
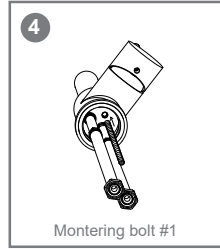
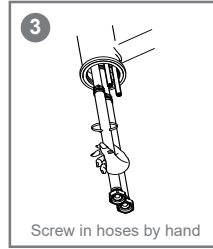
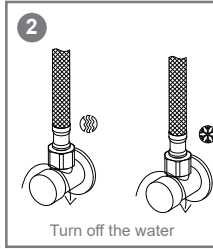
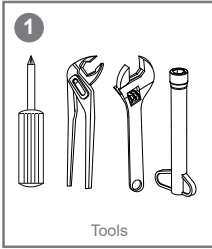

Questions & Answers

- There is too little water:
- Check for dirt in the aerator
 - Check for dirt in the connection hoses
 - Increase the water supply on the valve
 - Replace the aerator into one with higher flow rate
- There is too much water:
- Reduce water supply on the valve
 - Replace the aerator into one with less flow rate
- Water runs constantly:
- Turn off the water supply
 - Remove the handle
 - Replace the cartridge
- Water drips continuously from the spout:
- Turn off the water supply
 - Remove the handle
 - Replace the cartridge
- The faucet drips for a while after closing the handle:
- The aerator is stopped with dirt or lime
 - Clean, descale or replace the aerator
- Water drips from the handle:
- Turn off the water supply
 - Remove the handle
 - Replace the cartridge
- The handle moves tight:
- Turn off the water supply
 - Remove the handle
 - Replace the cartridge
- Leakings from the swivel spout
- Replace the rubber rings at the swivel.
 - Lubricate the new rubber rings with silicone grease
- Water flows down the hoses:
- The hose fittings are screwed in too little. Screw the hoses fully into the faucet, by hand only.
 - O-rings may be damaged, replace O-rings
- The swivel spout turns tight:
- Remove the spout and lubricate the rubber rings with silicone grease.
 - Silicone grease itself cannot repair a leak. In case of leaks, replace the rubber rings. lubricated with silicone grease before remounting the swivel spout
 - Rubber rings at the swivel spout are wearing parts and those are not covered by the drip guaranty

Spare parts

Spare parts drawings are available at www.adora-design.com

Technical data

- Test pressure: 25 bar
 - Operating pressure: 1-6 bar
 - Max. inlet water temperature: 80 °C
 - Test norm: 1-handle faucets EN817. 2-handle faucets EN 200
-

Disposal

Local national regulations on disposal and recycling must be observed.

Disclaimer

Nor the dealer, distributor or manufacturer can be liable for:

- Faults, defects, damage and consequential damage caused by incorrect installation
 - Faults, defects, damage and consequential damage caused by incorrect use
 - Damage caused by limestone and frost damage
 - Damage due to dirt from the water supply
 - Lack of maintenance
 - Faucets installed and used without following the user manual
 - Unnecessary violent behavior that causes damage to the product
-

Contact

www.adora-design.com - info@adora-design.com
