

ADORA®

A05.07 DK
Brugsvejledning

12902.XX COLOR
Infigo L-200 150CC
Topbruser med termostat



Anvendelse

- ADORA® Topbrusersæt med termostat er produceret med henblik på at forsyne et brusebad med koldt, varmt og blandet vand til personlig hygiejne
-

Garanti

- Der ydes 10 års garanti mod dryp og fabrikationsfejl. Garantien dækker reservedele
 - Købskvitteringen er produktets garantibevis. Opbevar købskvitteringen sammen med denne brugsvejledning
 - Det anbefales, at scanne eller kopiere kvitteringen, da trykssvæerte kan falme med tiden
-

Vedligeholdelse

- Armaturer med forkromede eller farvede overflader og armaturer i rustfrit stål skal aftørres umiddelbart efter brug
 - Temperaturgrebet skal med jævne mellemrum drejes til fuld varm position og til fuld kold position, da dette reducerer risiko for kalkbelægninger i termostat unit
 - Armaturer udført i rustfrit stål skal jævnligt overfladebehandles med plejeprodukter specielt til rustfrit stål
 - Rustfrit stål, der ikke vedligeholdes, risikerer at danne overfladerust
 - Topbruserens dyser gnubbes dagligt, eller efter behov, med hånden eller med et håndklæde
 - Topbruser skal afmonteres og afkalkes jævnligt, mindst hver 3. måned. Topbrusere der går i stykker på grund af tilkækning er ikke omfattet af garanti
-

Rengøring

- Anvend kun neutrale rengøringsmidler, der ikke er slibende eller kalkopløsende, og ikke indeholder syre, klor, eller fosfor
 - Ved brug af rengøringsmidler på spray, spray altid først på en klud og påfør derefter er med kluden. Ved direkte spray på armaturet er der risiko for at beskadige gummiringe og andre vitale dele
 - Anvend aldrig slibesvampe eller skuresvampe på armaturer
 - Armaturer udført i rustfrit stål skal jævnligt rengøres med rengøringsmidler fremstillet specielt til rustfrit stål
-

Montering

ADORA® armaturer skal monteres i en lovlig installation og i henhold til gældende lovgivning i det land armaturet monteres. Opstår der tvivl om korrekt installation, kontakt da en autoriseret VVS-installatør.

Installationens driftstryk skal være mellem 1 og 6 bar. Ved højere driftstryk skal der monteres tryk-reduktionsventiler på både koldt- og varmtvandstilgang. Armaturets fabriksindstillinger er udført ved et vandtryk på 3 bar på både kold og varm vandtilgang.

Hvis armaturet drypper eller ikke fungerer umiddelbart efter montering:

1. Lad armaturet forblive monteret, og luk for vandtilførslen.
2. Se punktet 'Spørgsmål & Svar' i denne vejledning
3. Se mere på www.adora-design.com eller skriv til: info@adora-design.com

Husk at vedhæfte foto af det installerede produkt, kopi af købskvittering og også evt. installationskvittering.

Før montering:

- Pak det nye topbrusersæt ud, og kontroller at filtrene sidder i omløberne på armaturet
- Skab overblik over indholdet
- Kontroller at installationen passer til de medfølgende monteringsdele
- Hvis installationen ikke passer til de medfølgende monteringsdele, anskaf da yderligere monteringsdele hos forhandleren
- Klargør det nødvendige værktøj
- Luk for vandtilførslen
- Afmonter det gamle armatur og brusesæt, og åbn lidt for vandet for at skylle installationen fri for snavs

Efter montering:

- Åbn reguleringsgrebet
- Åbn langsomt for vandtilførslen
- Aktiver termostatgrebet så der kommer vand ud, først koldt og derefter varmt vand.
- Luk reguleringsgrebet
- Kontroller at alle samlinger er tætte
- Gentag samme kontrol igen efter nogle timer for at sikre en succesfuld montering

Justering af termostat unit til at opnå varmere eller koldere starttemperatur ved 38°C mærket

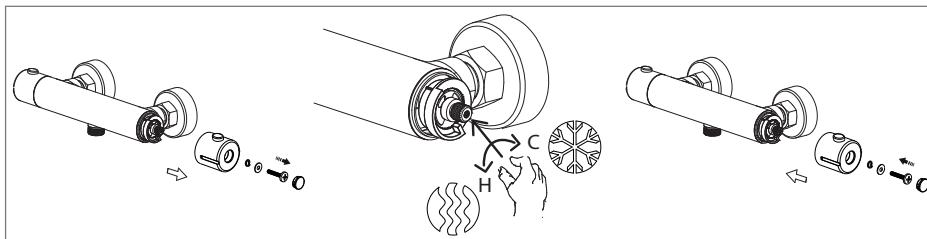

Nulstilling af termostat unit til 38°C starttemperatur

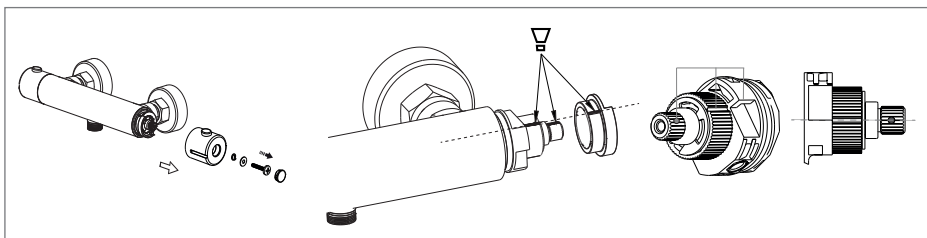

Rengøring af termostat unit

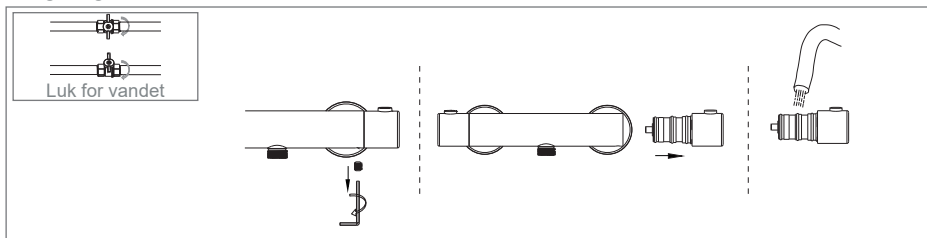

Topbrusersæt med termostat

3/4" R 20 tilslutning.
Centerafstand 150mm

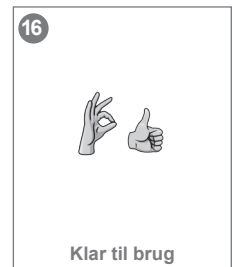
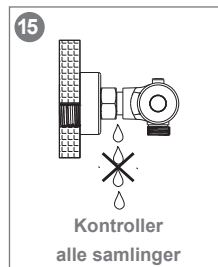
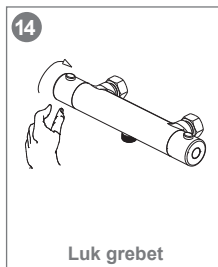
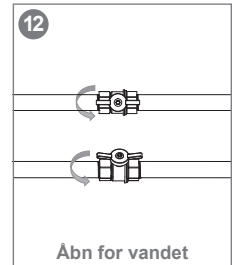
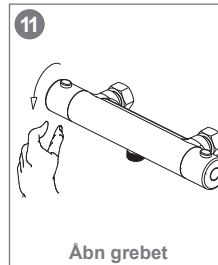
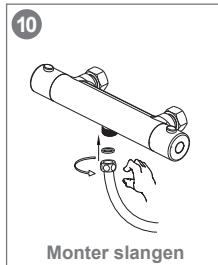
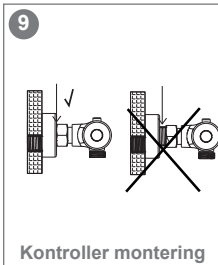
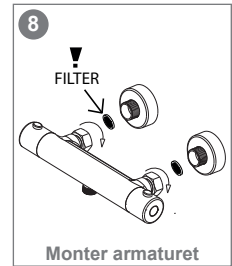
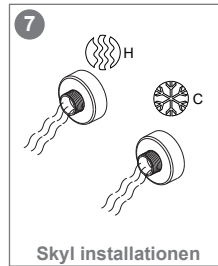
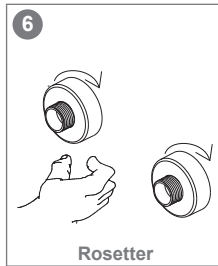
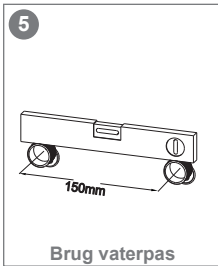
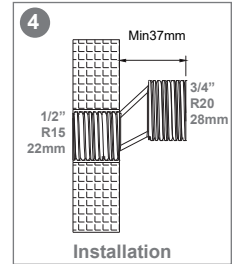
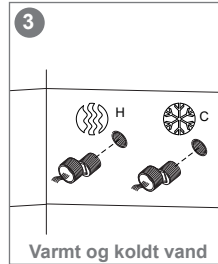
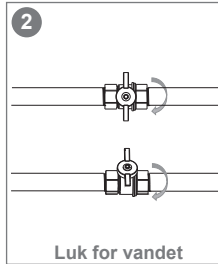
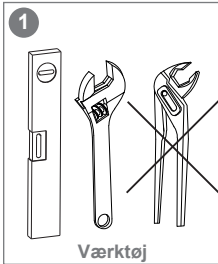

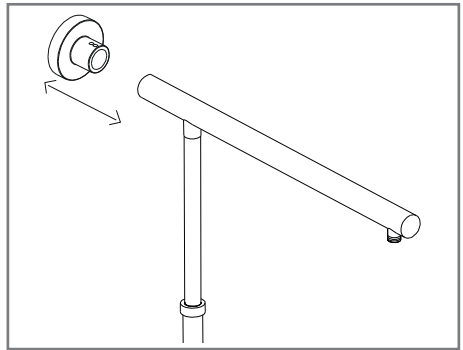
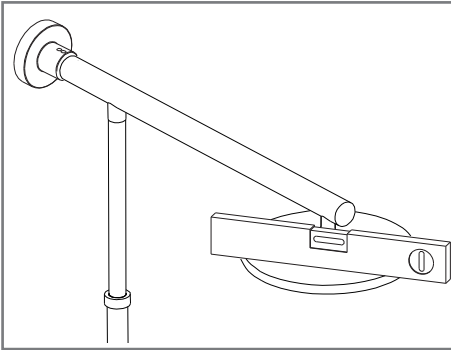
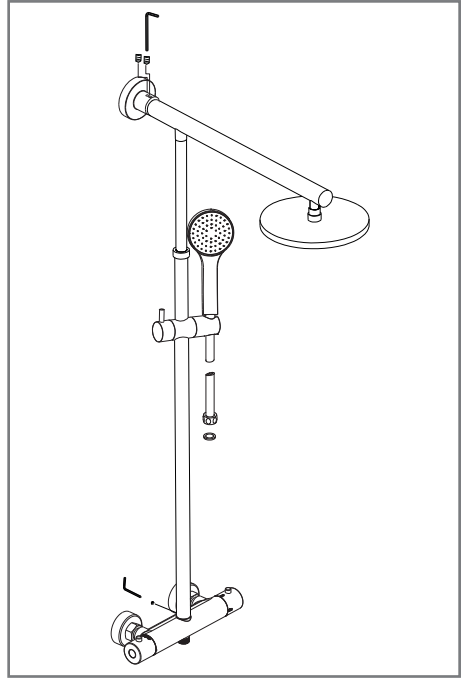
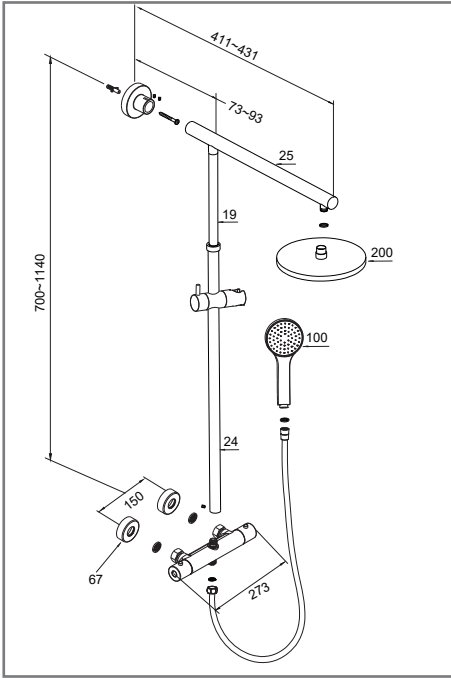

Afkalking af topbruser

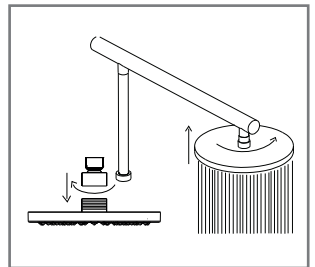
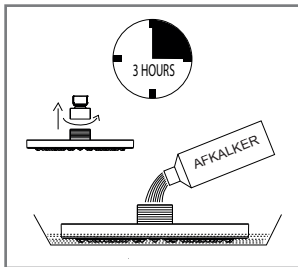
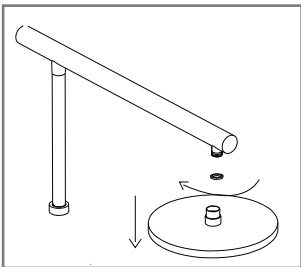

Spørgsmål & Svar

Armaturet fungerer ikke:	<ul style="list-style-type: none"> • Kontroller at armaturet er monteret med korrekt koldt-vands- og varmtvands tilslutning • Kold og varm er markeret med henholdsvis blå og rød farveindikation • I standardinstallationer er koldt vand til højre og varmt vand til venstre
Der kommer for lidt vand ud:	<p>Kontroller om:</p> <ul style="list-style-type: none"> • der er snavs i termostatunit filterne? • der er snavs i tilslutningsfilterne? • bruseslange er klemt? • håndbruseren har frit gennemløb? <p>Fjern en evt. vandspareindsats i håndbruseren.</p>
Der kommer for meget vand ud:	<ul style="list-style-type: none"> • Tilpas vandstrømmen på reguleringsgrebet • Skru ned for vandstrømmen på armaturet • Monter evt. en vandsparebruser
Vandet løber konstant:	<ul style="list-style-type: none"> • Luk for vandtilførslen • Udskift reguleringsdelen
Armaturet drypper vedvarende:	<ul style="list-style-type: none"> • Luk for vandtilførslen • Udskift reguleringsdelen
Der kommer vand ud ved reguleringsgrebet:	<ul style="list-style-type: none"> • Luk for vandtilførslen • Udskift reguleringsdelen
Reguleringsgrebet drejer trægt:	<ul style="list-style-type: none"> • Luk for vandtilførslen • Udskift reguleringsdelen
Der kommer vand ud ved termostatgrebet:	<ul style="list-style-type: none"> • Luk for vandtilførslen • Udskift termostatunit
Termostatgrebet drejer trægt:	<ul style="list-style-type: none"> • Luk for vandtilførslen • Afkalk eller udskift termostatunit
Gevind på væginstallation er for kort:	<ul style="list-style-type: none"> • Betyder at armaturet sidder løs • Monter armaturet med både filterpakning og den medfølgende ekstra pakning • Kun modeller med 150CC montering 3/4" R20
Håndbruseren drypper kortvarigt efter lukning af greb:	<ul style="list-style-type: none"> • Det er normalt. Det er det tilbageværende vand, der naturligt forlader brusehovedet
Topbruseren drypper kortvarigt efter lukning af greb:	<ul style="list-style-type: none"> • Topbruseren er ikke vandret, derfor forlader vandet brusehovedet • Juster topbruseren til vandret
Der kommer mindre vand ud af Topbruseren:	<ul style="list-style-type: none"> • Topbruseren er tilkalket • Afkalk topbruseren

Vandspare

Vandspareeffekt er angivet ud fra et vandtryk på 3 bar, og er i forhold til brusere og armaturer uden nogen form for vandstrømsregulering. Vandspareeffekt er angivet for topbruser.

Godkendelser

Angivne godkendelser og testnormer er relateret til termostatarmaturet.

Reservedele

Reservedelstegninger er tilgængelige på www.adora-design.com

Tekniske data

- Testtryk: 25 bar
 - Driftstryk: 1-6 bar
 - Maks vandtemperatur: 80 °C
 - Eco-stop
 - Skoldningssikring ved 38 °C
-

Bortskaffelse

Gældende nationale regler om bortskaffelse og genanvendelse skal overholdes.

Ansvarsfraskrivelse

Forhandler, distributør og producent kan ikke gøres erstatningspligtig for:

- Fejl, mangler, skader og følgeskader opstået i forbindelse med fejlmontering
 - Skader på grund af kalk, frost
 - Skader på grund af snavs fra vandforsyning
 - Manglende vedligeholdelse
 - Armaturer monteret og anvendt uden at følge brugsvejledningen
 - Unødvendig voldsom behandling, der påfører armaturet skade
-

Kontakt

www.adora-design.com - info@adora-design.com

ADORA®

A05.07 UK
User manual

12902.xx COLOR
Infigo L-200 150CC
Top shower set with thermostatic mixer



Intended nuse

- ADORA® top shower set with thermostatic mixer is manufactured to provide a shower with cold water, hot water and mixed water for personal hygiene
-

Guaranty

- A 10-year guaranty is granted against drip and manufacturing defects. The guaranty covers spare parts.
 - The purchase receipt is the product guaranty certificate. Keep the receipt together with the manual.
 - It is recommended to scan or copy the receipt, as printing ink may fade over time
-

Maintenance

- Mixers with chromed or colored surfaces and faucets in stainless steel must be wiped immediately after use
 - The temperature handle must be turned frequently to full hot and full cold position, this reduces the risk of limescale in the thermostatic unit
 - Stainless steel Mixers must be treated frequently with care products made especially for stainless steel
 - Stainless steel, which is not properly maintained, is likely to grow surface rust
 - The top shower nozzles are to be rubbed daily, by hand or with a towel
 - Top showers must be dismantled and descale regularly, at least every 3rd month.
 - Top showers that break due to calcification are not covered by the guaranty
-

Cleaning

- Use only neutral detergents that are not abrasive or lime-soluble and do not contain acid, chlorine, or phosphorus
 - When using sprayable detergents; always spray the detergent on a cloth first and then apply the cloth to the faucet. Direct spray on the faucet, gives a risk of damaging the rubber rings and other vital parts
 - Never use abrasive vapors or scouring sponges on faucets
 - Stainless steel faucets must be cleaned frequently with detergents made especially for stainless steel
-

Installation

ADORA® faucets shall be mounted in a legal installation and in accordance with applicable laws of the country in which the faucet is mounted. If there is any doubt about the correct installation, contact an authorized plumbing installer.

The operating pressure of the installation must be between 1 and 6 bar. At higher operating pressures, pressure reduction valves must be installed on both cold and hot water connections. The mixers factory settings are done at 3 bar pressure on hot and cold water.

If the faucet drips or does not work immediately after installation:

1. Leave the faucet installed and shut off the water supply
2. See the 'Questions & Answers' section in this manual
3. For more information go to www.adora-design.com or write to: info@adora-design.com

Remember to attach some photos of the installed product. Furthermore, a copy of the purchase receipt and if possible, the installation receipt.

Before installation:

- Unpack the new top shower set and check that the filters are in position in the mounting nuts of the mixer
- Make yourself an overview of the content
- Make sure that the installation is compatible with the supplied mounting parts.
- If the installation does not fit together with the supplied mounting parts, obtain additional mounting parts at the dealer
- Prepare the necessary tools
- Shut off the water supply
- Remove the old mixer and shower set, and turn the water slightly on to flush the installation free from dirt

After installation:

- Open the regulation handle
- Slowly turn on the water supply
- Activate the thermostatic handle, first cold and then hot water
- Close the regulation handle
- Check that all connections are tight, and not leaking
- Repeat the check after a few hours to ensure successful assembly

Adjustment of thermostatic unit to reach warmer or colder starting temperature at the 38°C mark

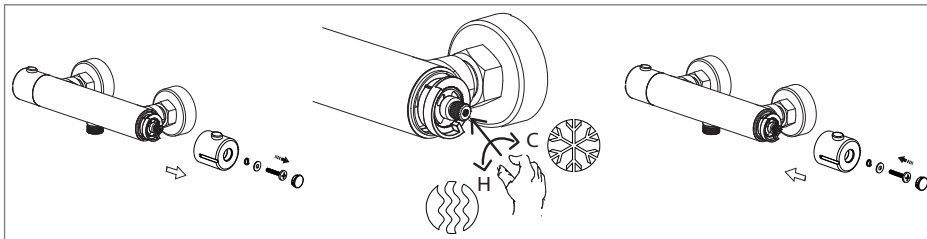

Re-setting thermostatic unit to 38°C starting temperature

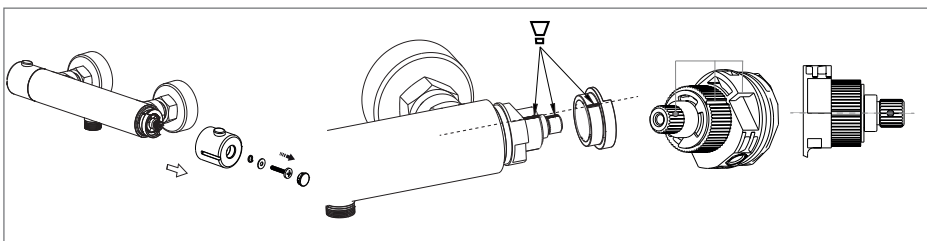

Cleaning thermostatic unit

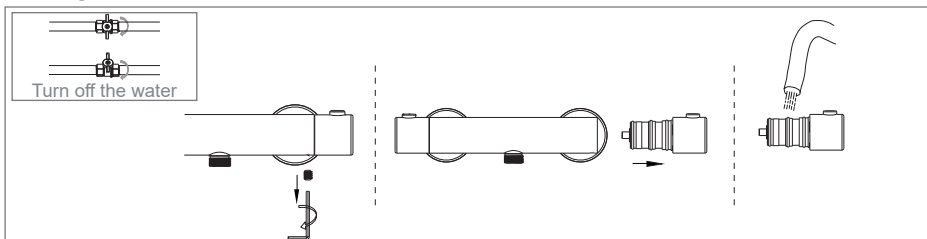

Top shower set with thermostatic mixer.
3/4" R20 connection. Center distance 150CC

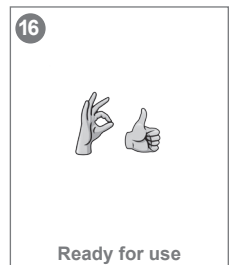
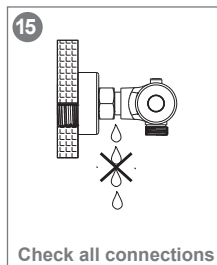
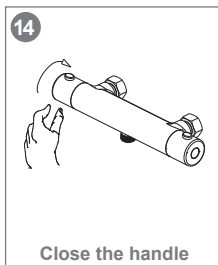
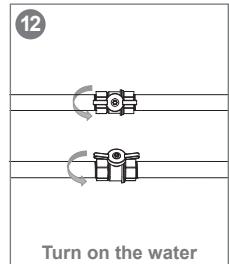
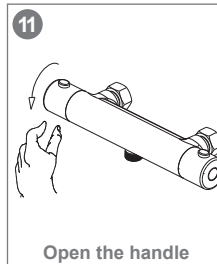
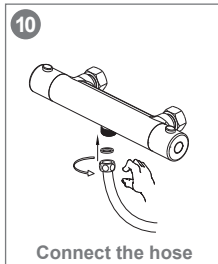
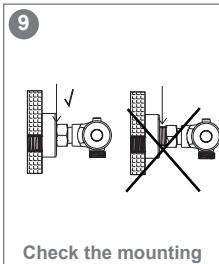
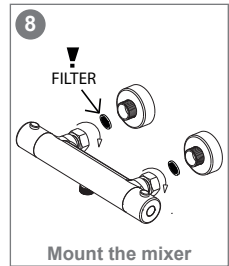
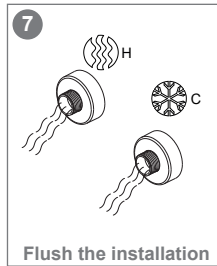
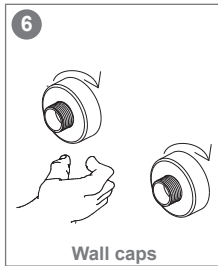
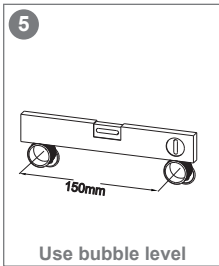
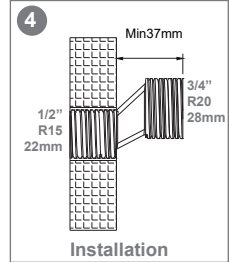
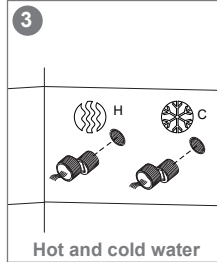
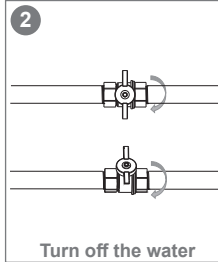
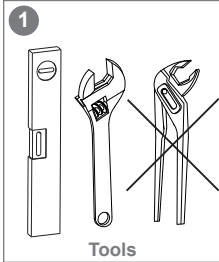

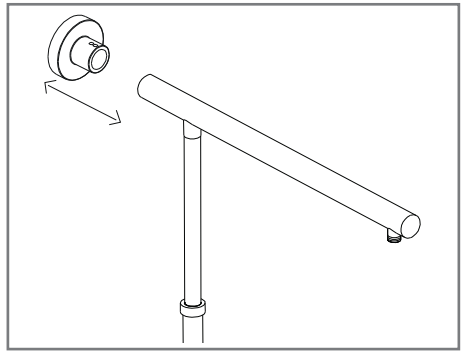
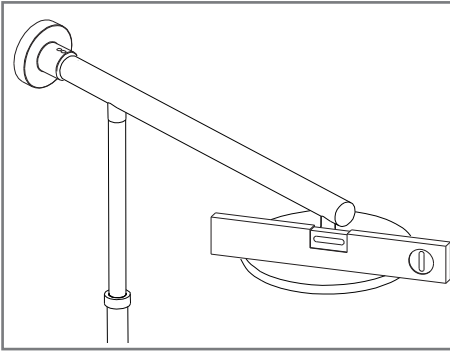
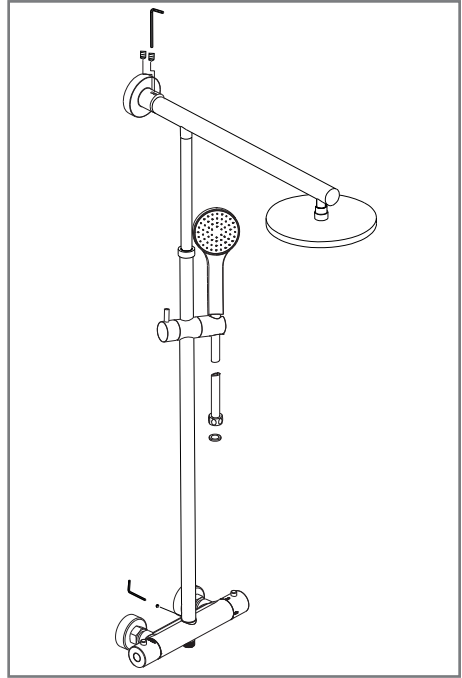
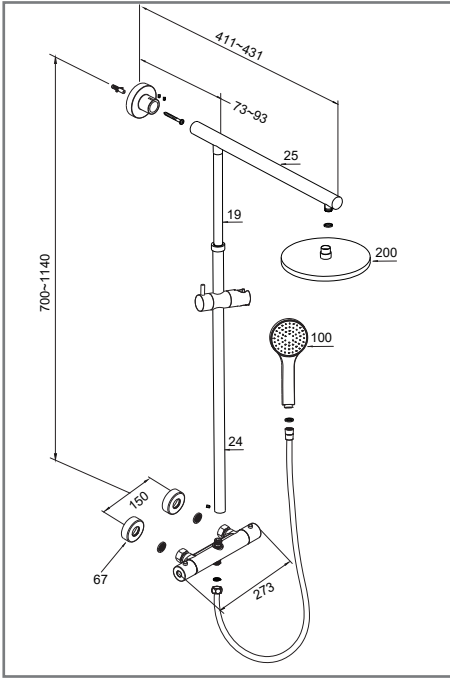

Descaling top shower

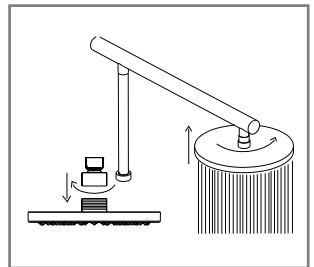
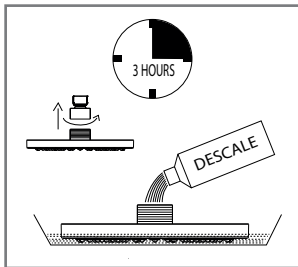
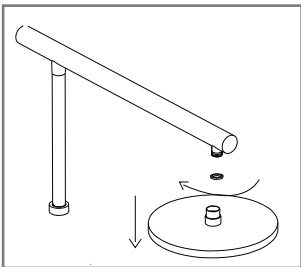

Questions & Answers

The mixer does not work:	<ul style="list-style-type: none"> • Check that the mixer is fitted with proper cold water and hot water connection • Hot is marked with red indication. Cold is marked with blue indication • In standard installations, cold water is to the right and hot water to the left
Too little water comes out:	<p>Check if:</p> <ul style="list-style-type: none"> • there is dirt in the thermostatic unit filters? • there is dirt in the connection filters? • shower hose is clamped? • the top shower and hand shower has free passage? <p>Remove any water saving device in the hand shower.</p>
Too much water comes out:	<ul style="list-style-type: none"> • Turn down the water flow on the mixer • Mount if necessary, a water-saving hand shower
Water runs constantly:	<ul style="list-style-type: none"> • Turn off the water supply • Replace the flow cartridge
Water drips continuously:	<ul style="list-style-type: none"> • Turn off the water supply • Replace the flow cartridge
Water comes out at the flow control handle:	<ul style="list-style-type: none"> • Turn off the water supply • Replace the flow cartridge
The flow control handle moves tight:	<ul style="list-style-type: none"> • Turn off the water supply • Replace the flow cartridge
Water comes out at the thermostat handle:	<ul style="list-style-type: none"> • Turn off the water supply • Replace thermostatic unit
The thermostatic handle moves tight:	<ul style="list-style-type: none"> • Turn off the water supply • Descale or replace the thermostatic unit
Wall installation threads are too short:	<ul style="list-style-type: none"> • Means that the mixer is loose • Mount the mixer with both the filter gasket and the supplied extra gasket. Only models with 150CC mounting
The hand shower drips briefly after closing handle:	<ul style="list-style-type: none"> • This is normal. The remaining water naturally the leaves the shower head
Top shower briefly drips after closing of the handle:	<ul style="list-style-type: none"> • The top shower is not in a horizontal position; therefore, the water naturally leaves the top shower Adjust the top shower to a horizontal position.
Less water comes out of the top shower:	<ul style="list-style-type: none"> • The top shower is calcified • Descale the top shower

Water save

Water saving effect is indicated by a water pressure of 3 bar and is compared to showers and mixers without any water flow control. Water saving effect is indicated for the top shower.

Approvals

Specified approvals and test norms are related to the thermostatic mixer

Spare parts

Spare parts drawings are available at www.adora-design.com

Technical data

- Test pressure: 25 bar
 - Operating pressure: 1-6 bar
 - Max. inlet water temperature: 80 °C
 - Eco-stop
 - Scald protection at 38 °C
 - Test norm: Mixer EN1111
-

Disposal

Local national regulations on disposal and recycling must be observed.

Disclaimer

Nor the dealer, distributor or manufacturer can be liable for:

- Faults, defects, damage and consequential damage caused by incorrect installation
 - Faults, defects, damage and consequential damage caused by incorrect use
 - Damage caused by limestone and frost damage
 - Damage due to dirt from the water supply
 - Lack of maintenance
 - Faucets installed and used without following the user manual
 - Unnecessary violent behavior that causes damage to the product
-

Contact

www.adora-design.com - info@adora-design.com
